

A DEVELOPMENT OF A TRAFFIC SIMULATOR FOR URBAN ROAD NETWORKS: AVENUE

Ryota Horiguchi*, Masahiko Katakura**,
Hirokazu Akahane*** and Masao Kuwahara****

* Kumagai Gumi Co., Ltd., 2-1 Tsukudo-cho, Shinjuku-ku, Tokyo 162, Japan

** Tokyo Metropolitan University, Tokyo

*** Chiba Institute of Technology, Chiba

**** Institute of Industrial Science, University of Tokyo, Tokyo

Abstract: This study develops AVENUE (an Advanced & Visual Evaluator for road Networks in Urban arEas). AVENUE incorporates a driver's route choice model and a traffic flow model that can reproduce over-saturated network conditions as well as under-saturated ones. The development of AVENUE is based on the object-oriented programming which affords flexible modifications to users' requirements and graphical environment for easy operations. This model was validated through an application to the Kinshicho area in Tokyo.

I. INTRODUCTION

As traffic congestion has caused serious social and economic problems in urban areas, there is a great demand for traffic simulation that can evaluate impacts of improvements on intersection geometry, traffic regulations, signal control, etc. Such a simulation system can be also an efficient tool for traffic assessment at planning stages of large events or urban developments.

So far, several traffic simulators for network assignment, such as CONTRAM^[1] and SATURN^[2], have been developed, but some problems are still remained in most of them^{[3][4]}. The most important problem is that they can not sufficiently deal with over-saturated traffic conditions.

In this paper, we will describe the development of AVENUE, which has the following distinctive features for its applications to urban traffic:

- 1) **Hybrid Block Density Method** -- In this method, a link is divided into several blocks. Density of every block is revised based on the flow-conservation law and the Flow-Density relationship, and discrete vehicle images are moved according to the calculated flow between the two neighboring blocks. Thus AVENUE reasonably reproduces queue blocking backs and conflicts of vehicles at intersections.
- 2) **Driver's Route Choice Module** -- To respond dynamic traffic situations on a road network, AVENUE incorporates driver's route choice module.
- 3) **Object-Oriented Traffic & Network Model** -- As the development of AVENUE is based on the Object-Oriented Programming, the system has a high flexibility to modify or extend its functions.
- 4) **Graphical User Interfaces** -- For easy operations and visual presentations, AVENUE employs graphical user interfaces.

II. HYBRID BLOCK DENSITY METHOD

AVENUE employs the hybrid representation of traffic flow, which treats traffic as the continuum

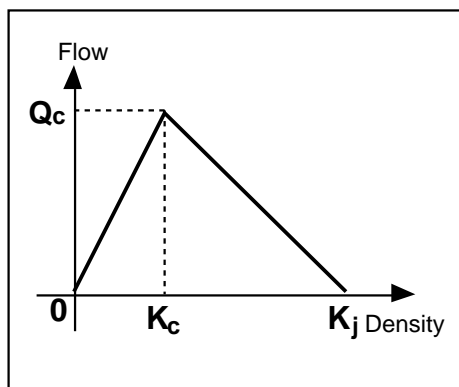

Figure 1. The Q-K curve for the Hybrid Block Density Method

flow using the Block Density Method^{[5][6]}, but at the same time it moves discrete vehicle images for the convenience of the route choice calculation and for handling conflicts of vehicles at intersections and lane changings. We, therefore, call the method as the Hybrid Block Density Method. In the traffic flow model, each link is divided into several blocks, the flows and the densities of which are revised backward from the downstream end of the link at every scanning interval based on the flow-conservation law and the Q-K relationships.

In this method, the length of each block, dL , is equal to the distance that a vehicle runs at the free-flow speed, V_f during the scanning interval, dt , and for every block i , the Q-K relationship must be specified in advance, which is assumed to be a triangle shape as shown in Figure 1 so as to be specified by three parameters of jam density K_j , critical density K_c , and maximum flow Q_c . Then, at every scan, according to the Q-K curve, the allowable outflow from block i , $A_i^{out}(t)$, and the allowable inflow to block i , $A_i^{in}(t)$, are calculated from the current traffic density $K_i(t)$ in block i as follows:

$$A_i^{out} = \min(Kc_i, K_i(t)) \frac{dL}{dt}, \quad (1)$$

$$A_i^{in}(t) = \begin{cases} (K_j - K_i(t)) \frac{dL}{dt}, & (K_i(t) \leq Kc_i), \\ \frac{Kc_i (K_j - K_i(t))}{K_j - Kc_i} \frac{dL}{dt}, & (Kc_i < K_i(t) \leq K_j), \end{cases} \quad (2)$$

As Figure 2 illustrates, the traffic flow $Q_{i,i+1}(t)$ between the neighboring downstream block i and upstream block $i+1$ is obtained by

$$Q_{i,i+1}(t) = \min(A_i^{in}(t), A_{i+1}^{out}(t)). \quad (3)$$

At the next scanning time $t+1$, the traffic density $K_i(t+1)$ is revised as

$$K_i(t+1) dL = K_i(t) dL - Q_{i-1,i}(t) dt + Q_{i,i+1}(t) dt. \quad (4)$$

These calculations can be applicable not only to under-saturated flow but also to over-saturated flow.

However, since $Q_{i,i+1}(t)$ is still continuum, there are additional procedures required to move discrete vehicle images for the implementation of the Hybrid Block Density Method. Firstly, $Q_{i,i+1}(t)$ is converted an integer number $M_{i,i+1}(t)$, vehicles of which are moved from block $i+1$ to i . The difference between $M_{i,i+1}(t)$ and $Q_{i,i+1}(t)$ will be moved to precede following vehicles at the next scanning time.

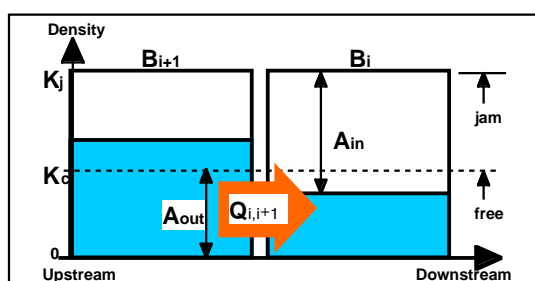

Figure 2. The calculation of the flow and densities between two blocks

III. OBJECT-ORIENTED TRAFFIC & NETWORK MODEL

The development of AVENUE is based on the Object-Oriented Programming which affords a high flexibility to describe the traffic model as well as to modify it^[7]. Figure 3 shows the identified classes and

their hierarchy and relationships for the Object-Oriented traffic model. Several basic classes that are the major actors in the various scenes on urban roads are mentioned below.

- 1) **Base-Node and Base-Link:** Objects of these classes form a network connected to each other. The class Base-Node has its subclasses OD-Node and Intersection-Node. An OD-Node corresponds to an end point where traffic flows into and out of a road network. The class Base-Link has attributes to its length, number of lanes, capacity, route guidance, etc. and relationships to the class Base-Block. The route guidance attribute contains the costs of the routes for every destinations. The route searching module updates the contents of the attribute in every specified time interval.
- 2) **Base-Vehicle:** Objects of this class have attributes to their origins and destinations, and furthermore, they have the method for the route choice. When a Base-Vehicle enters a Base-Link, it decides the next Base-Link to run into according to its destination and the route guidance attributes of the Base-Link. In the current version of AVENUE, a Base-Vehicle always chooses the minimum-time path.

- 3) **Base-Block:** Objects of this class relate to their up-stream and down-stream Base-Blocks and have the prototype method for the Hybrid Block Density Method. The prototype method is overridden by the specific one at the objects of the subclass derived from Base-Block such as Signal-Blocks whose flow calculation is controlled by the related Signal-Lights or Lane-Blocks which move Base-Vehicles only which satisfies the traffic regulations of the lanes.

IV. SYSTEM OUTLINE

AVENUE is implemented on G2^[8] that is an expert system upon UNIX workstations. G2 is originally developed for process plant control in real time, but it has sophisticated platform for the Object-Oriented Programming and construction of graphical user interfaces.

The operations of AVENUE are interactive through menu or dialog boxes with a mouse even during the simulation. As objects are displayed as icons, it is possible to visually recognize the details of traffic simulated as shown in Figure 4.

The input to AVENUE is road network data, sig-

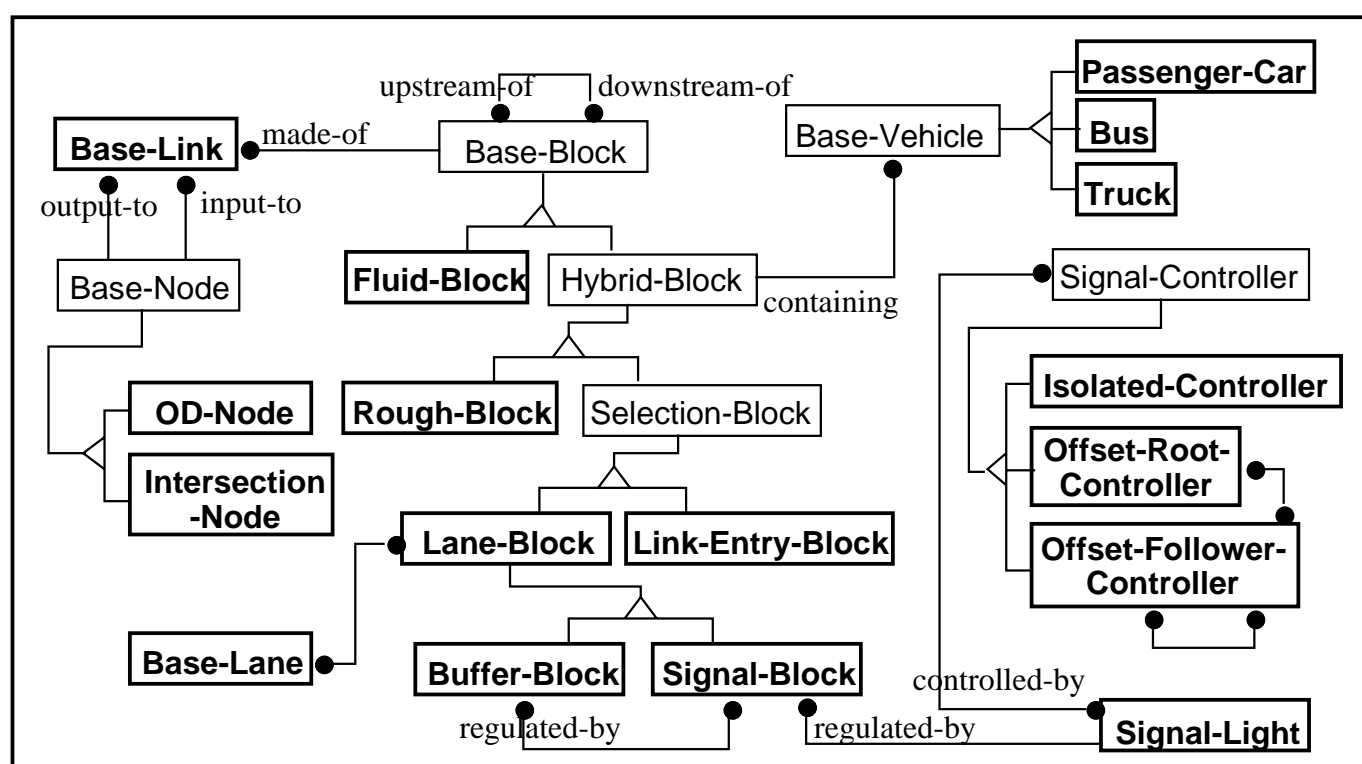

Figure 3. The object diagram for the traffic & network model of AVENUE according to OMT method

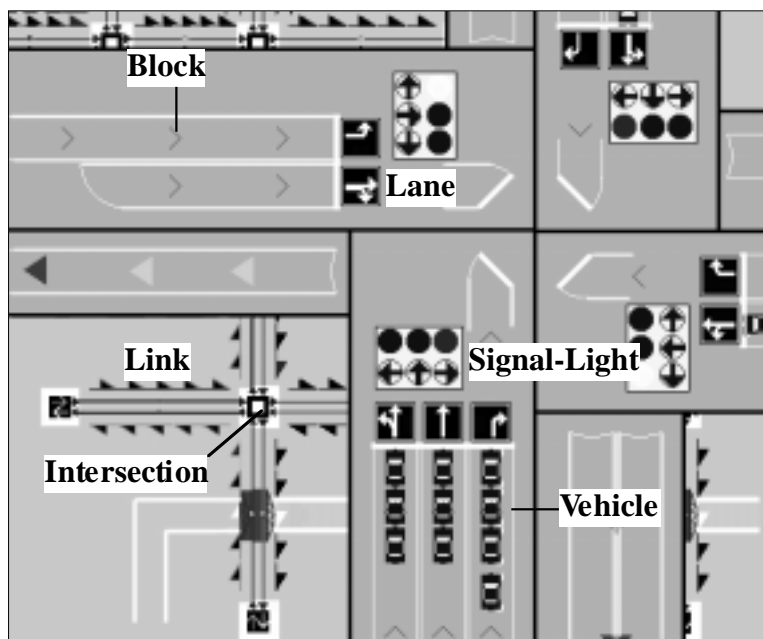

Figure 4. The display image of AVENUE

V. APPLICATION

Figure 5 shows the Kinshicho area in Tokyo where AVENUE was applied for the system validation. The section that is 600 meters in length has four intersections. The traffic data was collected during 8:00-10:00 and 12:00-14:00 on a weekday. Particularly, license plate numbers were recorded at boundaries of the study area to obtain the travel times on the links and the throughputs at intersections.

nal control parameters and the OD traffic demand. The results of the simulation are simultaneously displayed and other observed values listed below are recorded.

- travel times on links and between O-D pairs,
- queue lengths on links,
- throughputs of vehicles at intersections, etc.

Firstly, the data collected during 12:00-14:00 when the traffic volume was relatively small was analyzed. Figure 6a compares the observed count of vehicles discharged from Ryogoku-3-C with the simulated one. The data is aggregated in every signal cycle of 120 seconds. In spite of the large variation in the data, the first half of the simulation values reasonably correspond to the observed ones. However, the

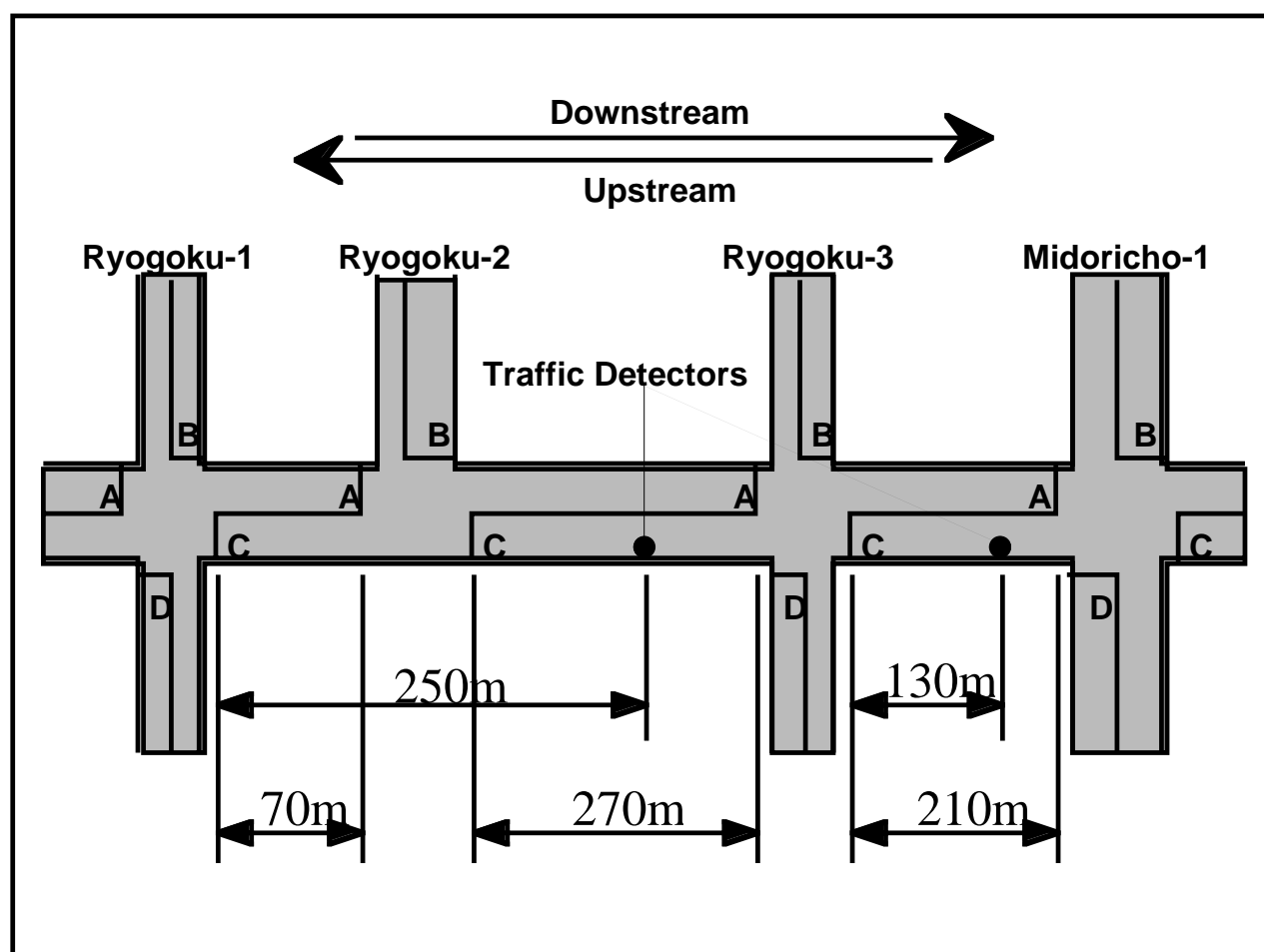

Figure 5. The road network used for the system validation

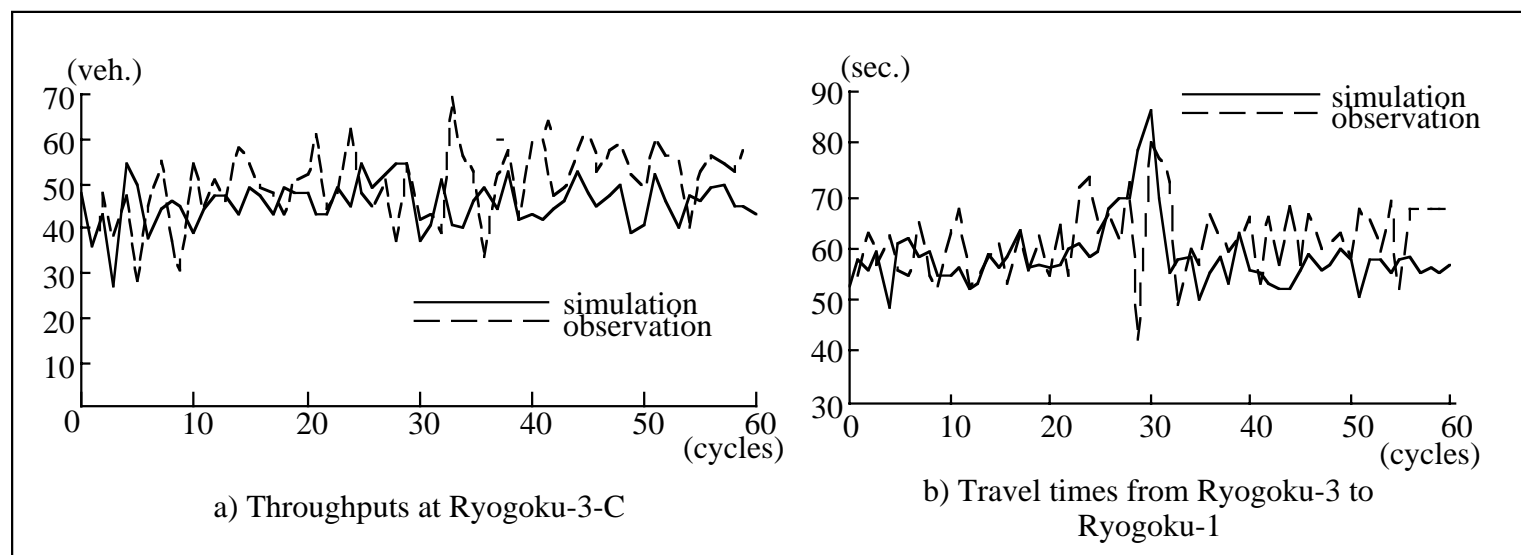

Figure 6. The comparison of the result of the simulation with the observed data from 12:00 to 14:00

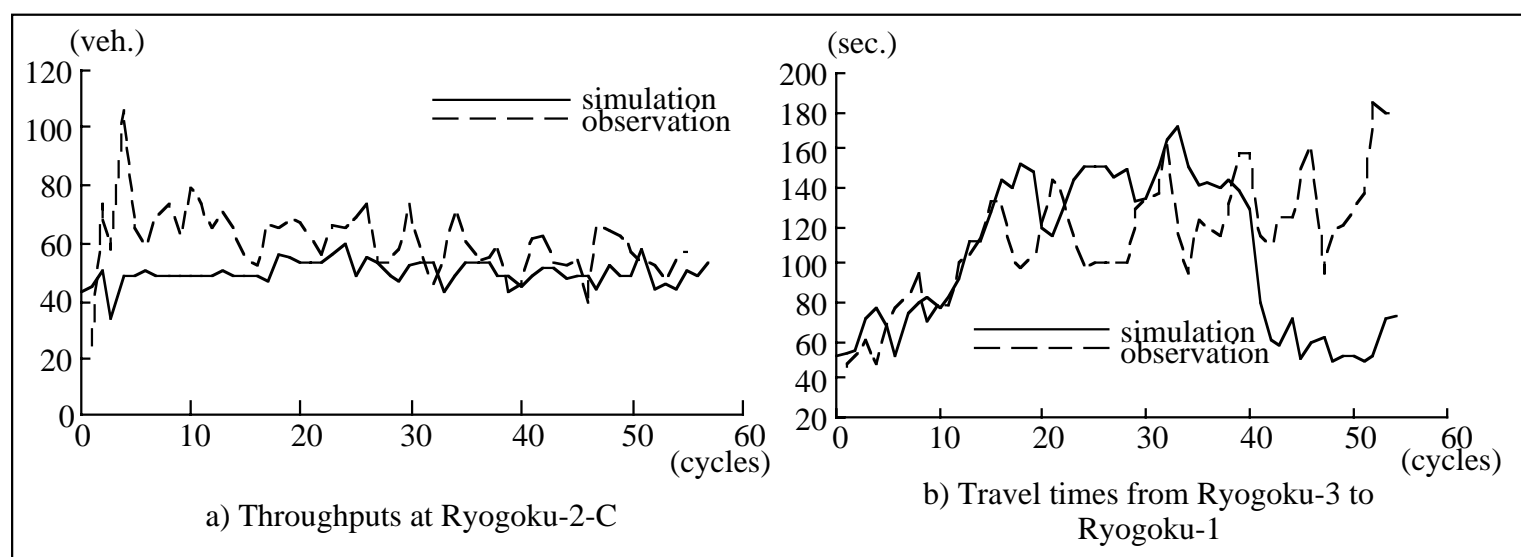

Figure 6. The comparison of the result of the simulation with the observed data from 8:00 to 10:00

second half of the simulation values are lower than the observed ones, which may be caused by the fact that the number of generated vehicles at the up-stream end of the network was smaller than the observed ones due to inadequate random number series.

Figure 6b shows the both travel times from Ryogoku-3 to Ryogoku-1. Taking averages, it was found that the simulation values are slightly smaller than the observed ones. This difference may come from the fact that the attribute of the free speed given to the link is greater than the actual speed of the free flow traffic and that there were several irregular data of portage cars whose travel times were more than 250 seconds among the observed data.

Secondly, the same comparison with the data collected between 8:00-10:00 when the upstream traffic

had larger volume and revealed congested state was conducted. Figure 7a shows the comparison of the count of vehicles discharged from Ryogoku-2-C. The simulated values are generally smaller than the observed values. This difference came from the complex lane usage that though the lanes at Ryogoku-2-C consists of 2 straight lanes and 1 right-turn lane in the simulation model, the actual traffic flowing straight also runs over the right-turn lane.

Figure 7b shows both the travel times from Ryogoku-3 to Ryogoku-1. The simulated values well follow the observed values which are increasing as the queue blocking back until 40th cycle, but thereafter, the simulated values become small. This is due to the fact that the number of the vehicles generated at the upstream-end of Ryogoku-3-B and D

decreases, so that the congested state along the stretch is dissolved earlier than the actual traffic.

In this application, the simple road network which has no alternative path for every O-D pair is employed to eliminate the influences of the route choice module. Though there are several points to be improved in the programming, the results shows that AVENUE could reproduce traffic flow on both under-saturated and over-saturated networks if the parameters which control the traffic flow are carefully adjusted.

As a next step, the validation including the influences of the route choice is being examined through the application to a more complicated network of a provincial city.

VI. CONCLUSION

This paper introduces the Hybrid Block Density Method and the concept of the traffic model used in AVENUE and reports its application to a simple real network. Although, through the validation, several points to be improved are found, AVENUE seems to be capable for various purposes such as

- optimization of signal parameters,
- evaluation of the effects of bus lanes, HOV lanes, or reversible lanes,
- planning for route guidance at emergency or large events,
- traffic assessment of large scale developments,
- evaluation of vehicle information and control systems, etc.

REFERENCES

[1] D.R. Leonard, J.B. Tough and P.C. Baguley, CONTRAM: A Traffic Assignment Model for Predicting Flows and Queues during Peak Periods, TRRL Report LR 841, 1978

- [2] M.D. Hall, Vliet D. Van. and L.G. Willumsen, A Simulation Assignment Model for the Evaluation of Traffic Management Schemes, Traffic Engineering & Control, Vol.21, No.4, pp.168-176, 1980
- [3] H. Oneyama, T. Okada, M. Kuwahara and T. Yoshii, A Study on the Vehicle Motion Logic of CONTRAM, Seisan-Kenkyu Vol.46, No.3, pp.54-57, Institute of Industrial Science, University of Tokyo, 1994, (In Japanese)
- [4] H. Inouye, A Dynamical Simulation Method of Traffic Flow on A Road Network, Journal of Infrastructure Planning and Management, No.470 / IV-20, pp.87-95, Japan Society of Civil Engineering, 1993, (In Japanese)
- [5] H. Ozaki, A Dynamic Traffic Simulator to Evaluate Signal Control (DESC), Traffic Engineering, Vol.24, No.6, pp.31-37, Japan Society of Traffic Engineers, 1989, (In Japanese)
- [6] I. Ueda, S. Tsubono, M. Kuwahara, H. Akahane and H. Ozaki, Development of a Traffic Simulation Model Incorporating Route Choice, Proceedings of Infrastructure Planning, No.14 (1), pp.279-286, 1991 (In Japanese)
- [7] J. Rumbaugh, et al., Object-Oriented Modeling and Design, Prentice Hall, Inc., 1991
- [8] G2 Reference Manual Version 3.0, Gensym Corporation, 1992